

YV2.8x2.8SA-SA2L Fujinon CS Mount Lens



INFO:

- 2.8-8mm (2.8x)
- Supports Up to 3 Megapixels
- F1.2 - T360 (Equivalent to F360)
- Auto Iris (DC Type)
- Manual Focus
- CS-Mount

DIMENSIONS:

Unit : mm

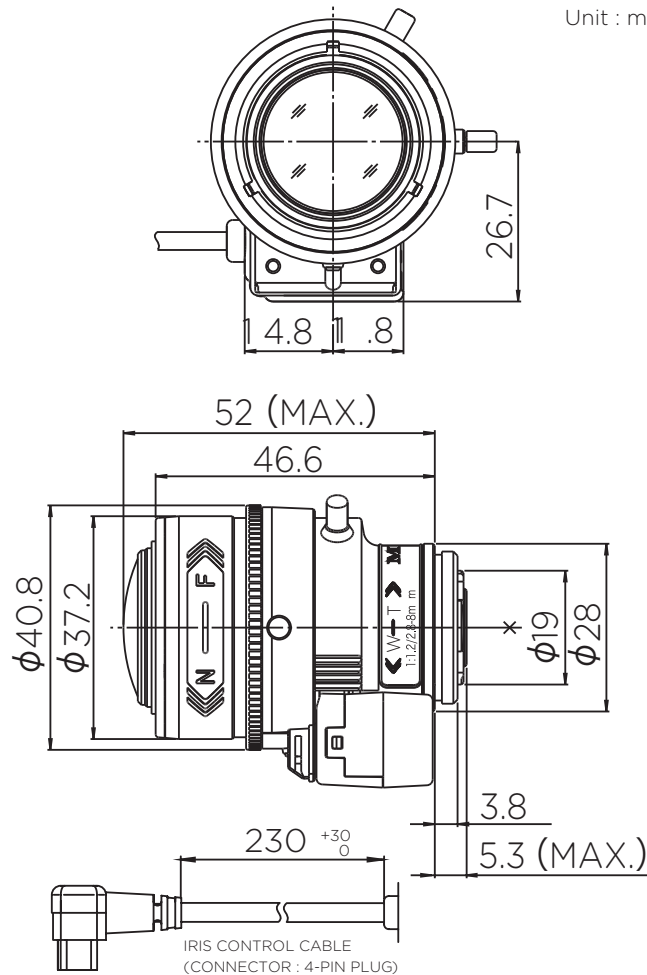

SPECIFICATIONS:

Focal Length	2.8-8mm (2.8x)
Iris Range	F1.2 - T360 (Equivalent to F360)
Iris Operation	Auto, DC Type
Focus Operation	Manual
Zoom Operation	Manual
Mounting Type	CS Mount, Metal
Focusing Range	∞ - 0.3m
Back Focus Distance (in air)	7.7mm
Operating Voltage	23 mA (Max.) @ DC 4V
Operating Temperature	-4°F - 140°F / -20°C - 60°C
Weight	.11 lbs / 50g
1/3" Angle of View	
Wide (4:3 Aspect Ratio)	100.00° × 73.45°
Tele (4:3 Aspect Ratio)	35.03° × 26.18°
Wide (16:9 Aspect Ratio)	109.50° × 59.51°
Tele (16:9 Aspect Ratio)	38.11° × 21.29°
1/4" Angle of View	
Wide (4:3 Aspect Ratio)	73.45° × 54.49°
Tele (4:3 Aspect Ratio)	26.18° × 19.44°
Wide (16:9 Aspect Ratio)	80.39° × 44.38°
Tele (16:9 Aspect Ratio)	28.39° × 16.07°